

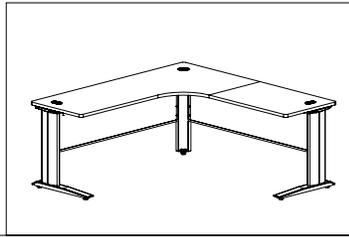

titan



ASSEMBLY INSTRUCTION

MODEL: TTN-7272CM

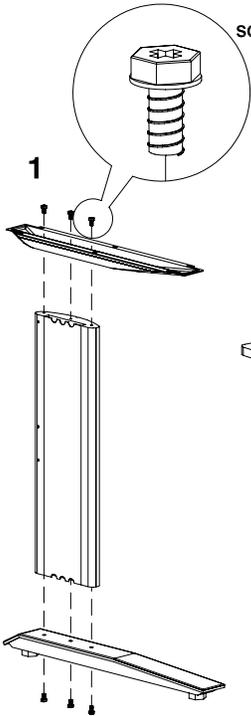

SCREW A

24 PCS



SCREW A

14 PCS



SCREW B

2 PCS



FLAT BRACKET

12 PCS



SCREW C

4 PCS

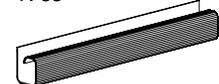

WIRE MANAGEMENT CHANNEL

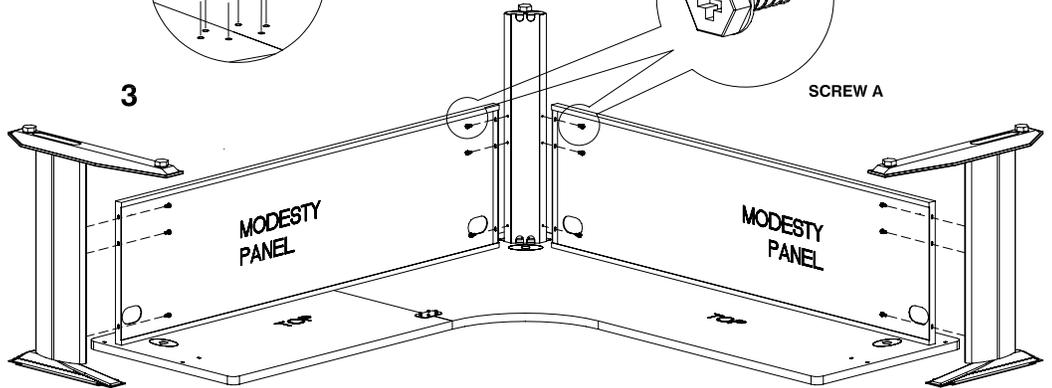
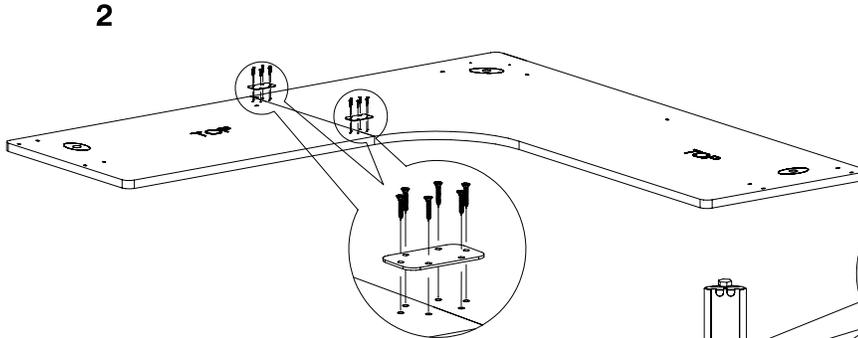

SCREW A

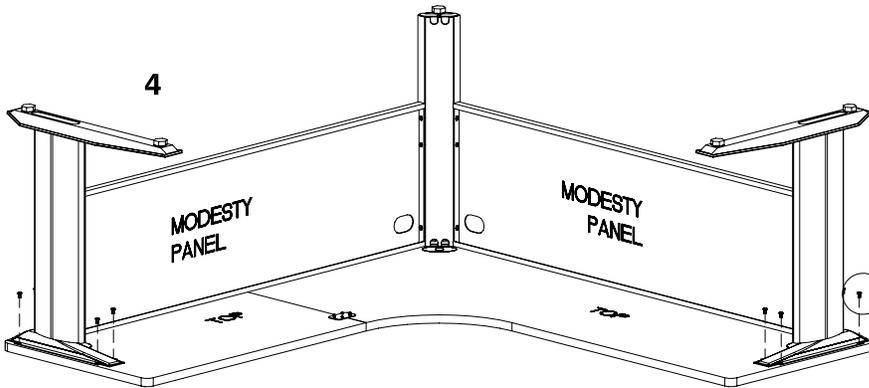

SCREW B

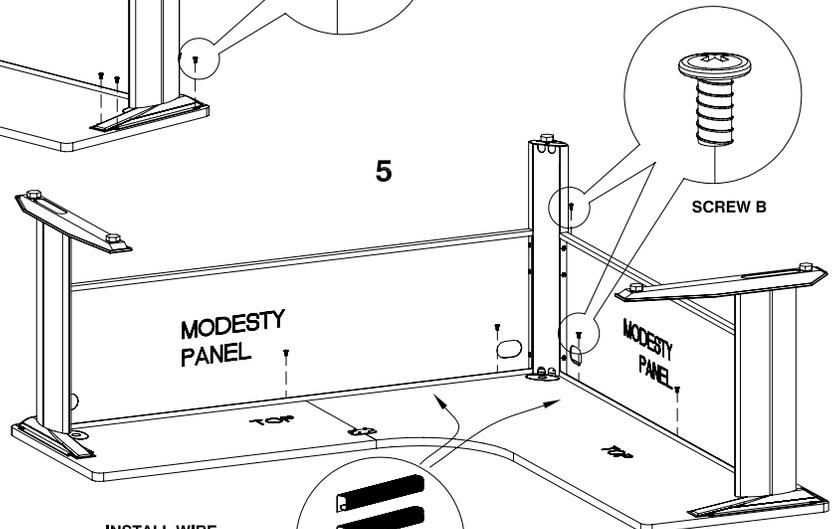

SCREW B

INSTALL WIRE MANAGEMENT CHANNELS WHERE APPROPRIATE

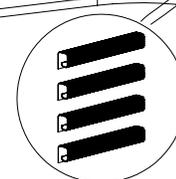

CAUTION:
 OFFICE FURNITURE IS HEAVY. ENSURE THAT YOU HAVE ADEQUATE ASSISTANCE WHEN LIFTING AND MOVING PARTS AND ASSEMBLIES. KEEP HARDWARE OUT OF REACH OF CHILDREN.

QUESTIONS OR CONCERNS ?
 PHONE Customer Service
 1-866-567-3060
 M-F 7am - 4:30 pm PST

NOVEMBER 10, 2008, REV F