

# CALYPSO SERIES

## HEIGHT ADJUSTABLE ELECTRIC BASES

*Designed to move with you!*



**2 LEG  
& 3 LEG  
MODELS**



### Features

- Quick Assembly - Fold-out leg frame
- Extended Height Range: 22" - 48" (excludes 1" top)
- Heavy duty 3-stage steel frame
- 4 programmable memory positions
- Actuator system with synchronized motor driving each leg
- Flexibility - designed to work with the **NEW** Innovations tops (sold separately) or RETRO FIT your existing top to this unit
- Contemporary offset foot leaves room for keyboard tray or other accessories
- Product is **IN-STOCK**

### Base Finishes



### Width Adjustment:

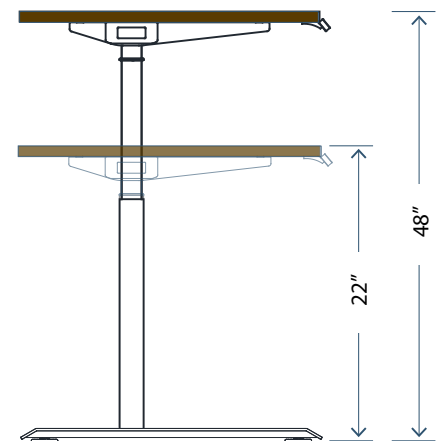
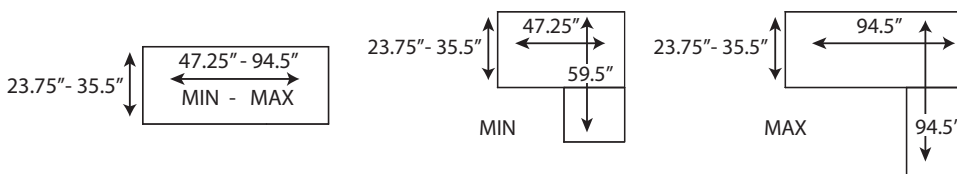

**Model:**  
CAL-E1-2LEG  
CAL-E1-3LEG

**Description:**  
Straight Desk  
L Shape Desk



## Technical Specifications:

- Anti-collision function - stops automatically if it hits an immovable object
- Actuator system with synchronized motor driving each leg
- Operated at 1.3" per second
- Whisper quiet <50dB
- Lifting Capacity: 2-LEG - 265lbs  
3-LEG - 320lbs
- CSA/UL Certified
- BIFMA Certified



Adjustable glides for easy leveling on uneven surfaces



Easy to use key pad with 4 programmable memory positions



Accessory: Wire Management 100-WM1300

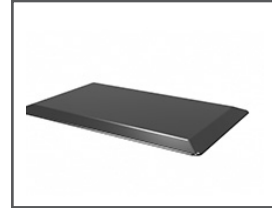

Accessory: Anti-fatigue Mat 100-2030AFM



Accessory: Hanging CPU holder 100-2-HPCU

## Innovations Laminate Tops

### Model:

INV-2436TOP (Return Only)

INV-2442TOP

INV-2448TOP

INV-3060TOP

INV-3066TOP

INV-3072TOP

INV-362466ECM

INV-362471ECM

### Description:

35.5"W x 23.75"D x 1"H

41.5"W x 23.75D x 1"H

47.25"W x 23.75D x 1"H

59.25"W x 29.5"D x 1"H

65"W x 29.5"D x 1"H

71"W x 29.5"D x 1"H

65"W x 35.5/23.75"D x 1"H

71"W x 35.5/23.75"D x 1"H

### Optional Caster

#### 900-CASTER-M8-MB

- Sold quantity 2 casters  
2 leg base - 2 set required  
3 leg base - 3 sets required
- Durable PVC material
- Safe for use on soft or hard floors
- M8 threaded stem caster
- Maximum weight 32kg/66lbs per caster



### Examples:



+ CAL-E1-2LEG

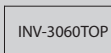

+ CAL-E1-2LEG

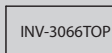

+ CAL-E1-2LEG

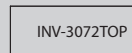

+ CAL-E1-2LEG

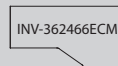

+ CAL-E1-2LEG  
+CAL-E1-2LEG-CMF

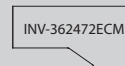

+ CAL-E1-2LEG  
+CAL-E1-2LEG-CMF



INV-2436TOP  
INV-2442TOP  
or  
INV-2448TOP

+ CAL-E1-3LEG



INV-2436TOP  
INV-2442TOP  
or  
INV-2448TOP

+ CAL-E1-3LEG

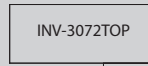

INV-2436TOP  
INV-2442TOP  
or  
INV-2448TOP

+ CAL-E1-3LEG

### Laminate Top Finishes:



Autumn Maple (AM)

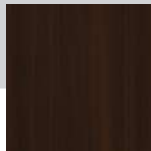

Evening Zen (EZ)



Grey (GR)

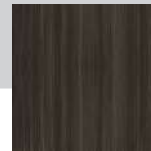

Grey Dusk (GD)



Hardrock Maple (HM)

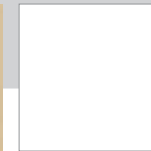

Pure White (PW)



Royal Mahogany (RM)

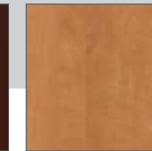

Sugar Maple (SM)



Winter Wood (WW)



## Heartwood Distributors Ltd.

Choose high quality, price sensitive products that are **IN-STOCK** and ready for next day shipping.

[www.heartwooddl.com](http://www.heartwooddl.com)

Contact your local dealer:

251 Adams Rd, Kelowna, BC V1X 7R1

T: 1 800 567 3060

F: 250 765 1213