

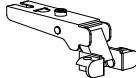

**MODEL: INV-STCDRS -AL
PIN-STCDRS -AL
ELT-STCDRS -AL**

<p>2 PCS</p>  <p>DOOR BUMPERS</p>	<p>4 PCS</p>  <p>DOOR HINGE</p>	<p>8 PCS</p>  <p>HINGE MOUNTING SCREW</p>	<p>4 PCS</p>  <p>HINGE PLATE</p>	<p>8 PCS</p>  <p>M6 X 12mm EURO SCREW</p>
--	--	--	--	--



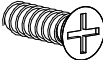
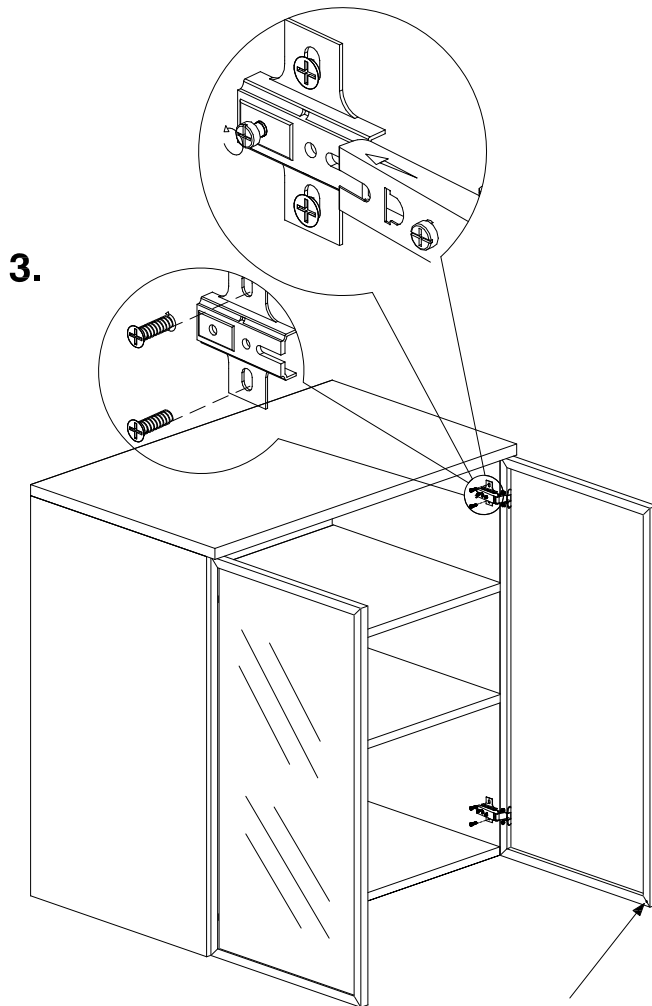
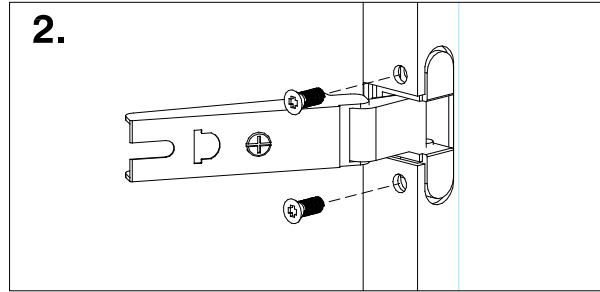
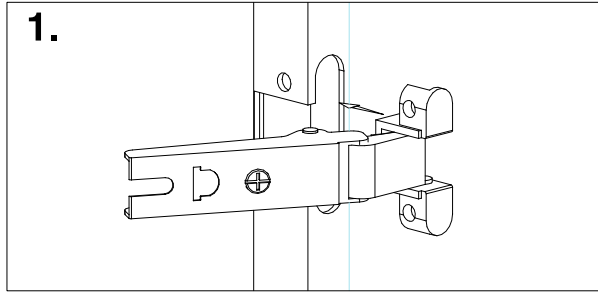

APPLY DOOR BUMPERS

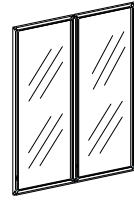
CAUTION:
OFFICE FURNITURE IS HEAVY. ENSURE THAT YOU HAVE ADEQUATE ASSISTANCE WHEN LIFTING AND MOVING PARTS AND ASSEMBLIES. KEEP HARDWARE OUT OF REACH OF CHILDREN.

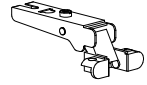

**MODÈLES: INV-STCDRS-AL
PIN-STCDRS -AL
ELT-STCDRS -AL**

<p>2 PIÈCES</p>  <p>COUSSINETS DE PORTE</p>	<p>4 PIÈCES</p>  <p>CHARNIÈRE DE PORTE</p>	<p>8 PIÈCES</p>  <p>VIS DE MONTAGE DE CHARNIÈRE</p>	<p>4 PIÈCES</p>  <p>PLAQUES DE MONTAGE POUR CHARNIÈRES</p>	<p>8 PIÈCES</p>  <p>VIS EURO M6 DE 12mm</p>
--	---	--	--	--

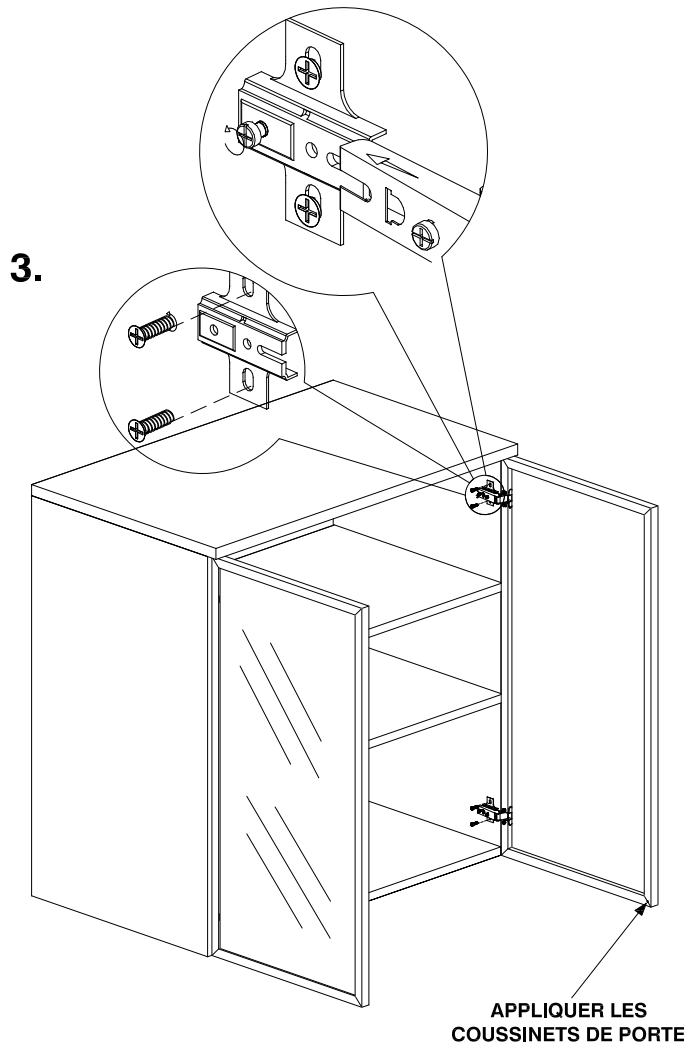
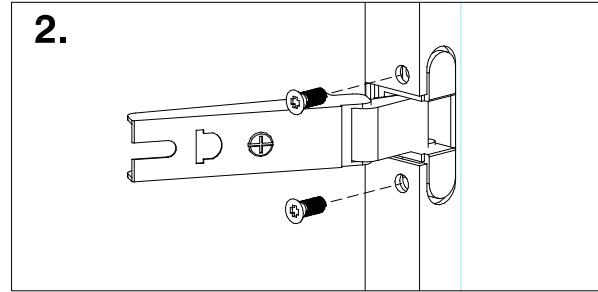
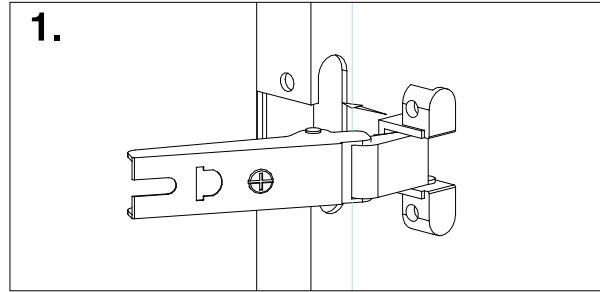

ATTENTION :

CET ARTICLE EST LOURD. DEMANDER TOUJOURS DE L'AIDE POUR SOULEVER OU DÉPLACER LES COMPOSANTES ET LES MODULES. TENIR LA QUINCAILLERIE D'AMEUBLEMENT HORS DE LA PORTÉE DES ENFANTS.